

Building in the Residential 1 & 1A Zones



Invercargill City
**District
Plan 2019**



Residential 1 and 1A Zone

When building or renovating there are many standards and rules to be aware of. Included in these are the planning standards set out in the Invercargill City District Plan.

This brochure aims to identify the key planning issues for building a residence in the Residential 1 and 1A Zones under the Invercargill City District Plan. If you are not able to meet these standards you will need to either obtain resource consent or change your plans.

The Key Issues:

The main considerations when designing your dwelling in terms of meeting the Planning requirements are

- Density of housing
- Outdoor living
- Space around buildings
- Site coverage / permeable surfaces
- Height
- Car parking and manoeuvring
- Private ways and right of ways.

Density

For residential activities the maximum residential density in the Residential 1 and 1A Zone is one residence per 400 square metres under contiguous ownership. There is an exception for sites smaller than this where the certificate of title existed as at 29 October 2016.

The Residential 1A Zone differs slightly to the Residential 1 Zone by the introduction of a Medium Density Housing rule. This allows development on a discretionary basis on sites held in contiguous ownership of 2000m² or greater. Medium Density Housing is defined in the District Plan as being a development of four or more dwellings with an average density of less than 350m² per dwelling. Please contact the Council's Planning staff for more information on this if you think this applies to you.

Outdoor Living

A designated area of outdoor living space must be provided on the site. For residences at or near ground level, it must be a minimum of 30 square metres in size and sufficiently large enough to accommodate a horizontal circle with a 5 metre diameter. The space must be free of buildings (other than conservatories) and not form part of the site used for vehicle parking or manoeuvring. For residences located one storey above the ground floor a balcony is to be provided. The balcony must be minimum 15 square metres in area and have a minimum horizontal dimension of 2.5 metres.

When considering the location of this outdoor living space, it is recommended that some thought be given to its position to maximise sunlight and daylight into the living areas of the dwelling and the potential connections, both visually and physically, between this space and the internal living areas.

Space around buildings

For residential activities a yard at least 2 metres deep is to be provided along each of the two northernmost boundaries of the site. This space must be kept clear and unobstructed by structures from the ground upwards, except for accessory buildings no greater than six metres in length and eaves of any building and any roof, gutter, or downpipe which extends no more than 0.6m over the yard. The yard may include the outdoor living area.

For non-residential activities a yard at least four metres deep must be provided along all side and rear boundaries.

In determining the northernmost boundaries of the site the two boundaries that face nearest to North are used. In an instance where the site faces due north then the second "northernmost boundary" can be either the eastern or western boundaries.

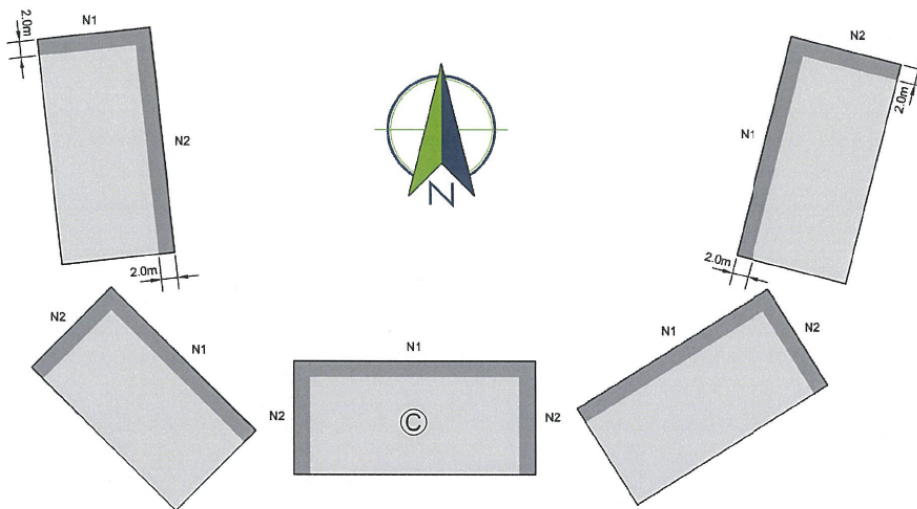

Please note that these are set backs required by Planning. You will need to talk to the Building Consents staff to ensure that there are no overriding setback requirements such as fire rating.

Site coverage / Permeable surfaces

The maximum coverage of buildings on the site must not exceed 40% of the net site area.

When calculating the net site area you cannot include any area subject to a designation for any purpose and/or any strip of land less than six metres in width.

An area of permeable surface must also be provided on the site and comprise at least 30% of the gross site area. This can be any type of ground surface treatment that allows for surface water to soak into the ground e.g. grass, garden beds.

Example of Complying Site Plan

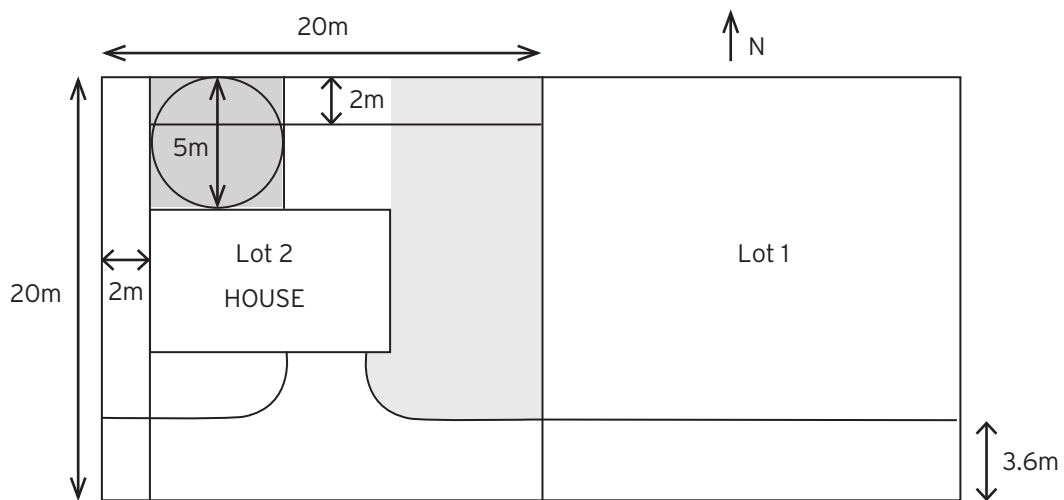

House = 150m²

Net site Area = 400m²

Site coverage = 37.5%



Outdoor living space 30m² minimum



Permeable surface 120m²

Height

The maximum height for buildings and structures and additions to existing building and structures is 10 metres.

Height is determined using the rolling height method which measures the vertical distance across the whole site between existing ground level and the top of that part of the building immediately above.

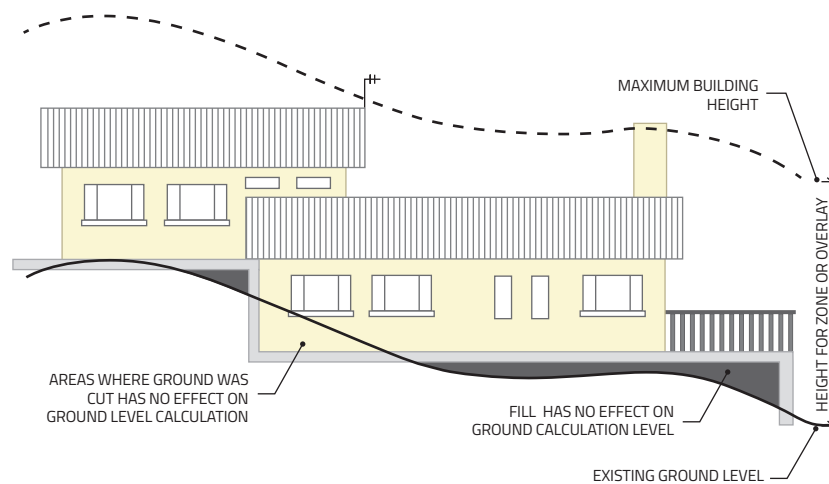

ROLLING BUILDING HEIGHT IS MEASURED VERTICALLY ACROSS THE WHOLE SITE FROM EXISTING GROUND LEVEL TO THE MAXIMUM BUILDING HEIGHT FOR THAT ZONE.

ROLLING HEIGHT METHOD

In calculating height account is not taken of lightning rods, chimneys, steeples, towers, turrets, spires, finials, dormer windows, ventilation shafts, water tanks, elevator lofts, solar heating devices and similar architectural features and parts of a building, providing that the feature is incorporated within the footprint of the building and does not exceed the maximum height limit of 10m and any relevant height recession plane by more than 1.5 metres, and the maximum width of the incursion does not exceed 2 metres. This is limited to one incursion per boundary.

The top portion of a gable end or the end of a wall with a mono-pitched roof, including any associated overhanging eaves and/or spouting, are also exempt from the height calculations provided that the maximum height of 10 metres and any relevant height recession planes are not exceeded by more than 1.5 metres and the maximum width of the incursion does not exceed 3 metres. This is also limited to one incursion per boundary.

Recession Plane Angles

All buildings are to be located within the building envelope created by recession planes. Recession planes are used to calculate the permitted height of buildings and structures in relation to their distance from boundaries. In general, the further the building is from the property boundary the higher it can be. The recession planes are calculated to reduce shading and to ensure a minimum allowance of sun and natural light for both you and your adjoining neighbours.

The recession planes used in the Proposed Invercargill City District Plan are as follows:

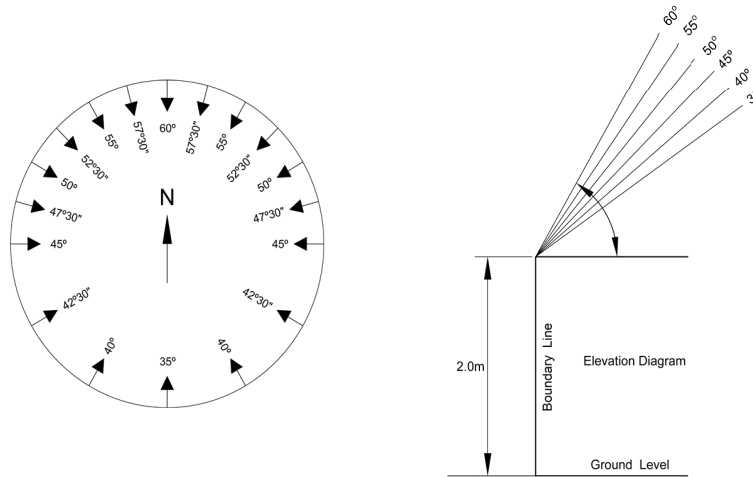

The recession plane angle shall be calculated by orienting both the site plan and relevant diagram to the true north, placing the recession diagram over the site plan with the circle tangential to the inside of the site boundary under consideration. The recession plane angle shall be that indicated by the diagram at the point where it touches the site boundary.

The recession planes for accessory buildings shall commence at points 2.2 metres above site boundaries. In all other instances, the recession plans shall commence at points 2.0 metres above site boundaries.

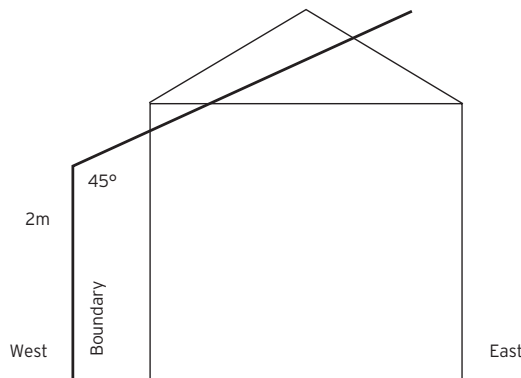

Example of house not complying with the recession plane

Car parking and manoeuvring

You are required to provide a car parking space for at least one vehicle on your property. One car park needs to be provided for residential units which are 150 square metres or smaller and two car parks need to be provided for residences larger than 150 square metres. This does not necessarily need to be in the form of a garage or carport but needs to be a hard standing area and be designed to comply with the car parking standards set out in Appendix 9 of the District Plan.

If your property is a back section (not fronting the street) you are also required to provide manoeuvring space on your property. This is to ensure that you can enter and leave the site in a forward gear. The size and construction of this manoeuvring space needs to be designed to comply with the diagram below.

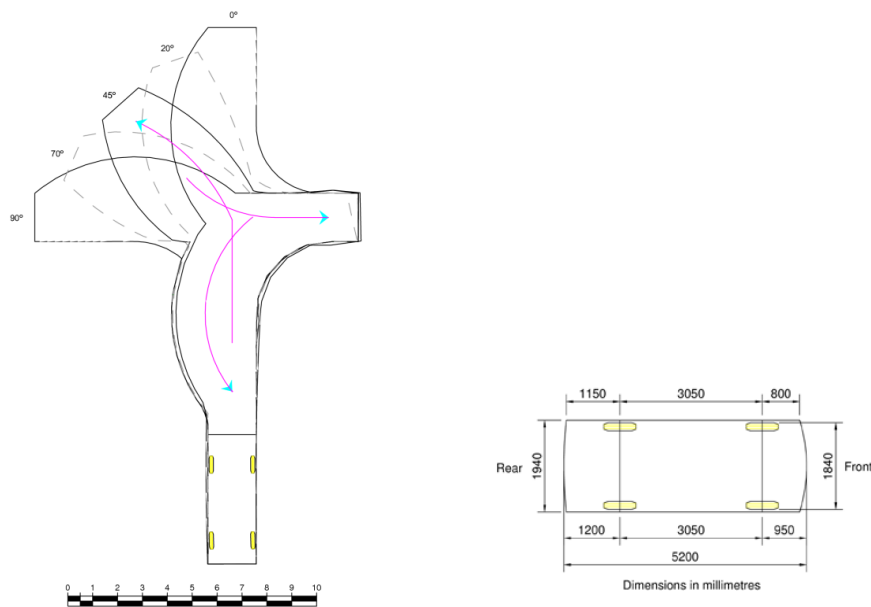

For residences fronting the street, where there is no manoeuvring space provided on the site and a garage is built with the door positioned towards the street, a setback of 5.2 metres needs to be provided from the garage door to the property boundary.

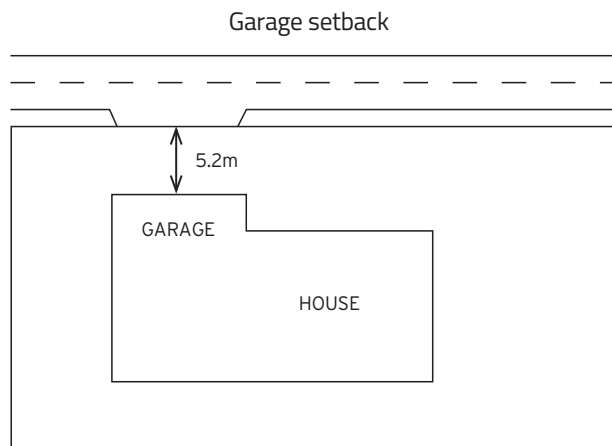

Private ways and right of ways

Private ways and right of ways (or driveway as more commonly known) need to be designed and constructed to comply with certain standards so as to ensure safety is achieved and to maintain a certain level of amenity. The width and standard of construction vary depending on the number of lots being served. These are set out below:

Residential 1, 1A, and 2 Zones			
Number of Lots	2-3	4-6	7+
Minimum Width	3.6m	4.5m	9m
Formed Movement lane	3m (sealed 5m in from property boundary)	3m (sealed 5m in from property boundary)	6m (sealed 5m in from property boundary)
Drainage	Interceptor sump required where more than 40m ² of impermeable area is graded towards the street.	Interceptor sump required where more than 40m ² of impermeable area is graded towards the street.	Interceptor sump required where more than 40m ² of impermeable area is graded towards the street.
Passing Bays	-	-	Every 50m, as set out in Appendix VIII of the Proposed District Plan.
Turning Heads	-	-	As set out in as set out in Appendix VIII of the Proposed District Plan.
Footpaths	-	-	Single sided, 1.5m width for concrete or 1.8m width for asphalt.
Lighting	-	-	Constructed and designed in accordance with Class P4 of AS/NZS 1158.

Do your Homework!

You are advised to discuss your individual project with and Invercargill City Council Resource Management Officer early in the planning process. Additional standards not covered in this brochure may apply depending on the characteristics of your individual property. For example, the land may be in a high flood risk area, or there may be covenants on your Certificate of Title restricting where you can build.

If you are not able to meet the minimum standards set out in this brochure you will either need to amend your plans or obtain resource consent to continue. For guidance on the consent process please talk to the Duty Planner and refer to the Invercargill City Council booklet "Resource Consents Landuse – a guide to making a resource consent application" which is available on our website.

Advice

If you require further information please contact the Duty Planner by phoning (03) 211 1777, emailing duty.planner@icc.govt.nz or resourceconsents@icc.govt.nz or by visiting the Council's Administration Building, 101 Esk Street, Invercargill. The office is open from Monday to Friday, 9.00am to 1.00pm.



Invercargill City Council

Private Bag 90104 | Invercargill 9840

EMAIL planning@icc.govt.nz | WEBSITE www.icc.govt.nz

Planning Department

PHONE 03 211 1777